

DIMENSIONAL DRAWING: 3203

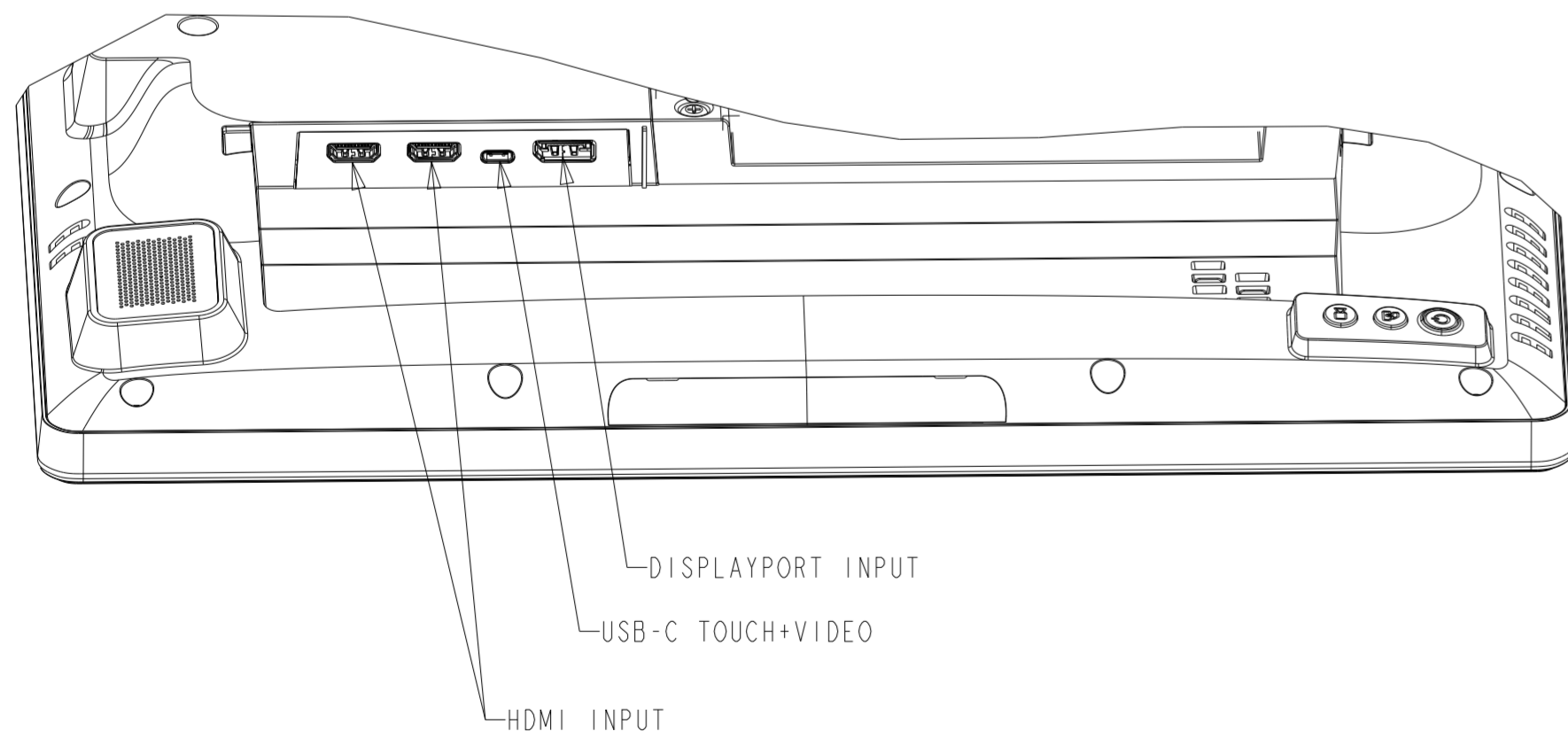

DIMENSIONAL DRAWING: 3203

OPTIONAL LOW-PROFILE WALLMOUNT KIT P/N E721949  
PURCHASED SEPARATELY, CUSTOMER ASSEMBLED

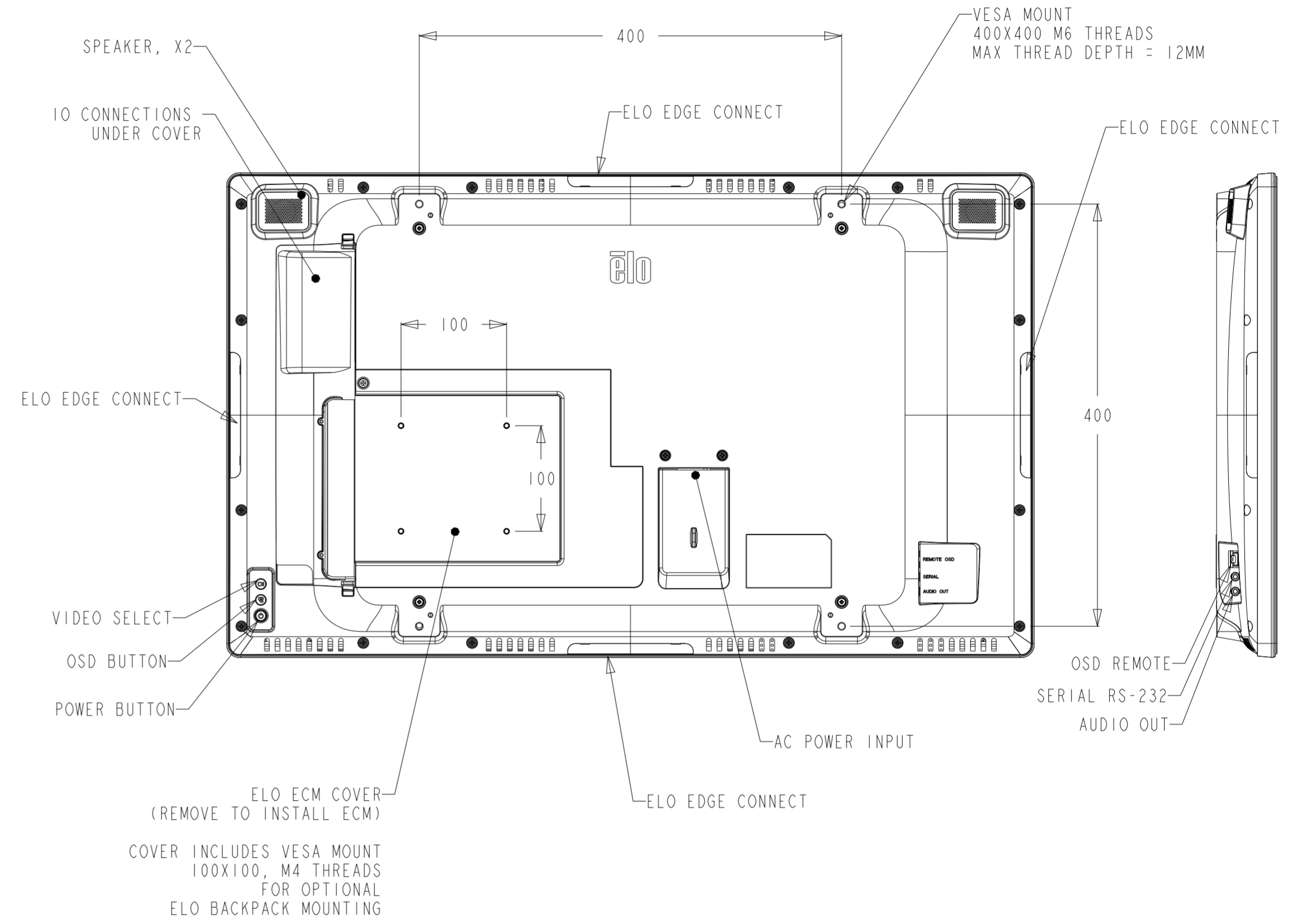
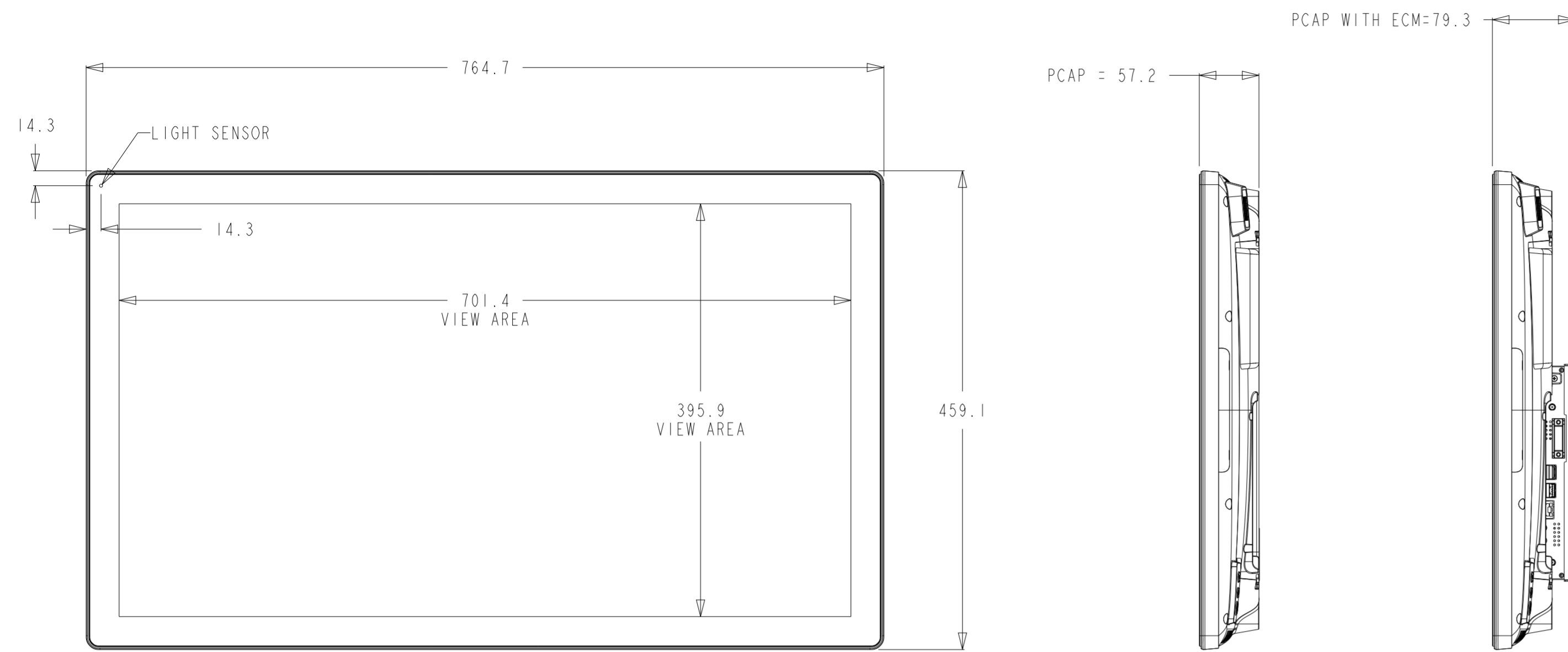
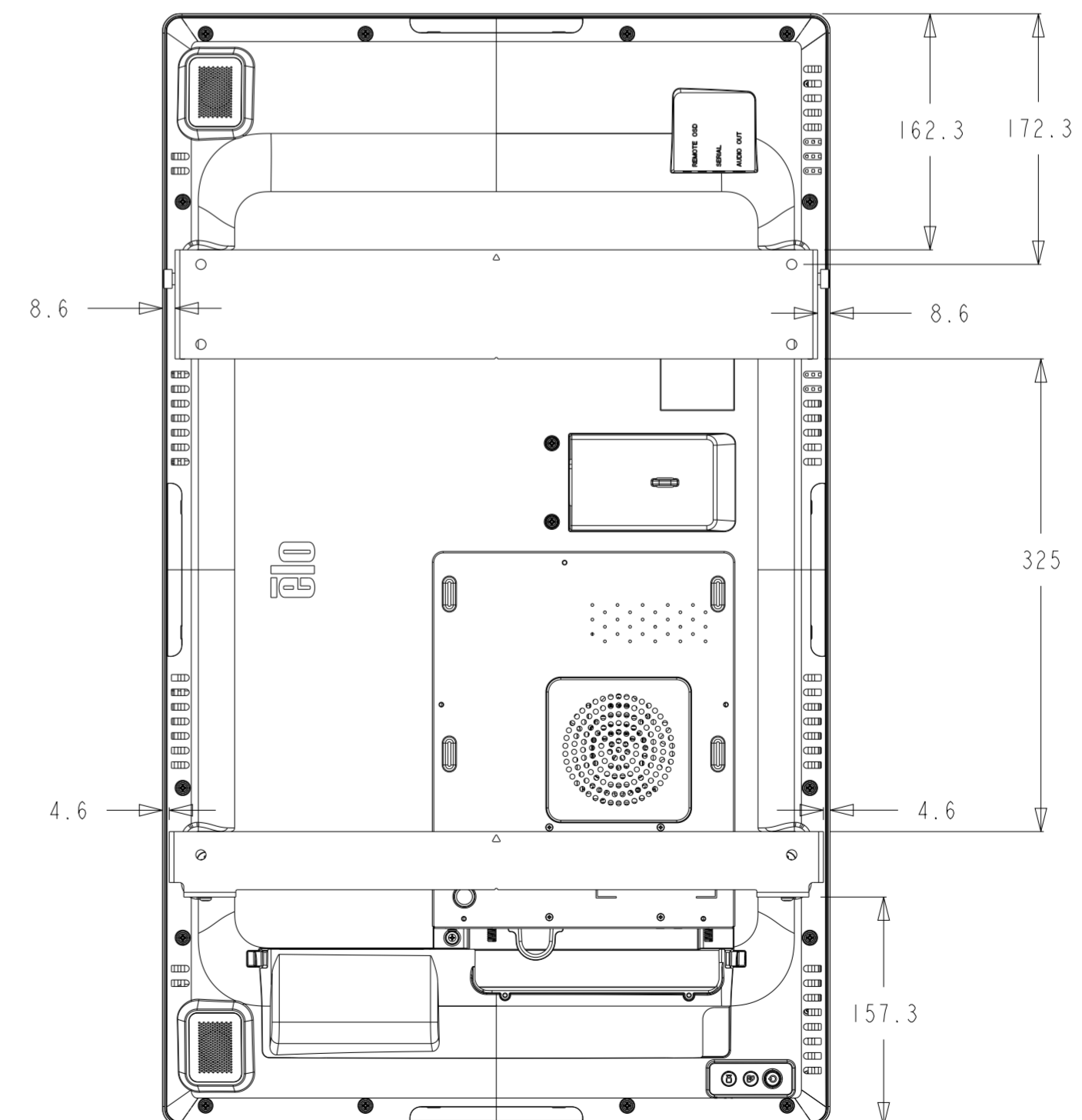
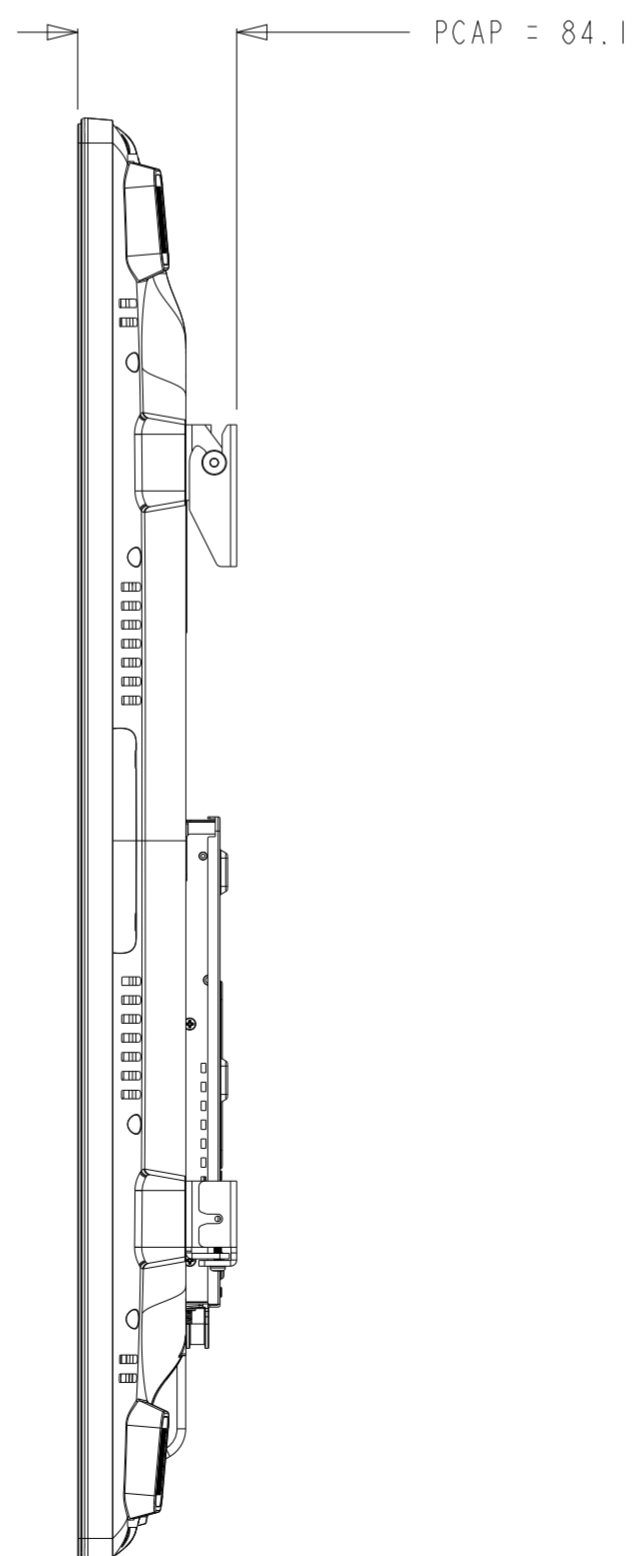
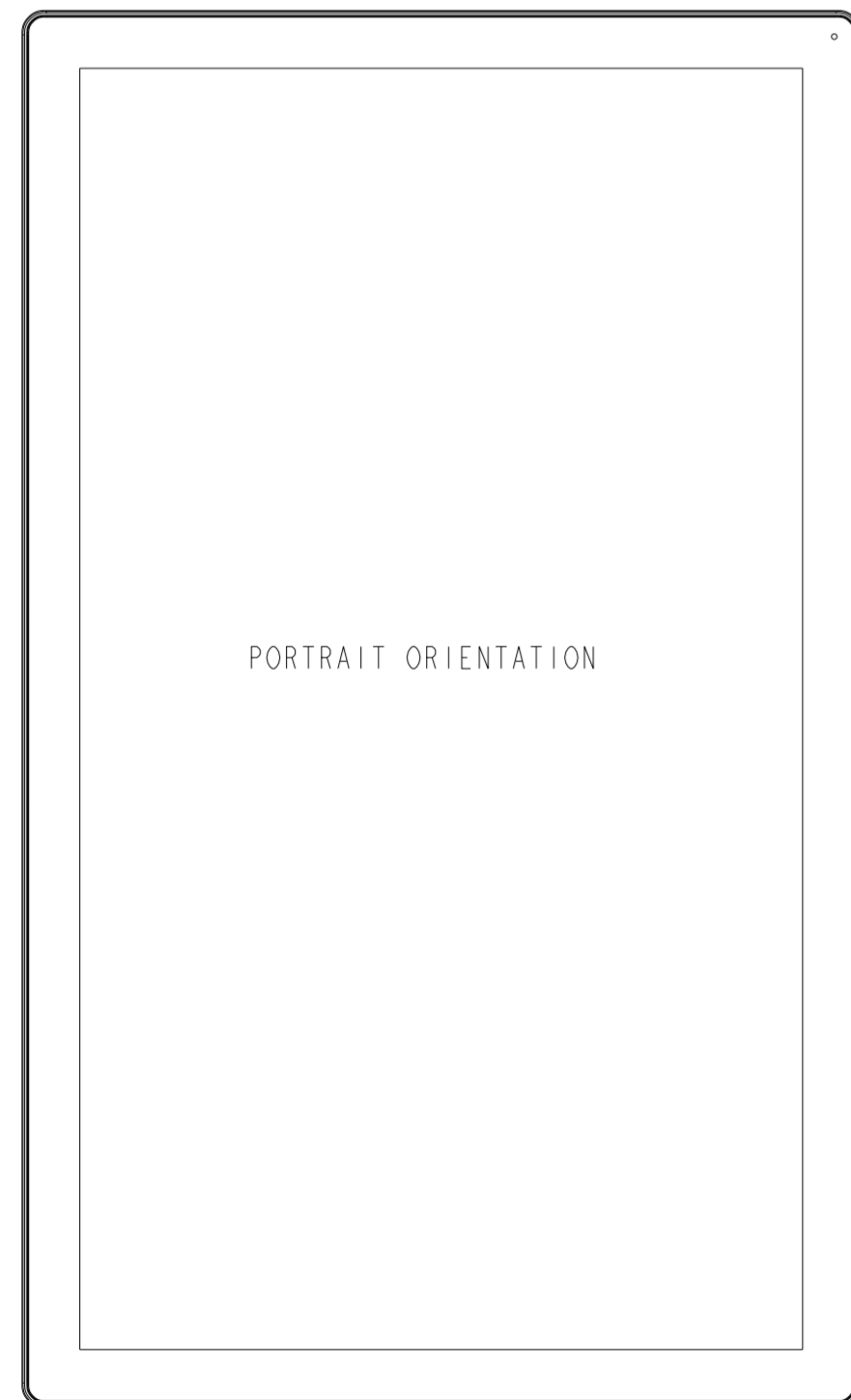
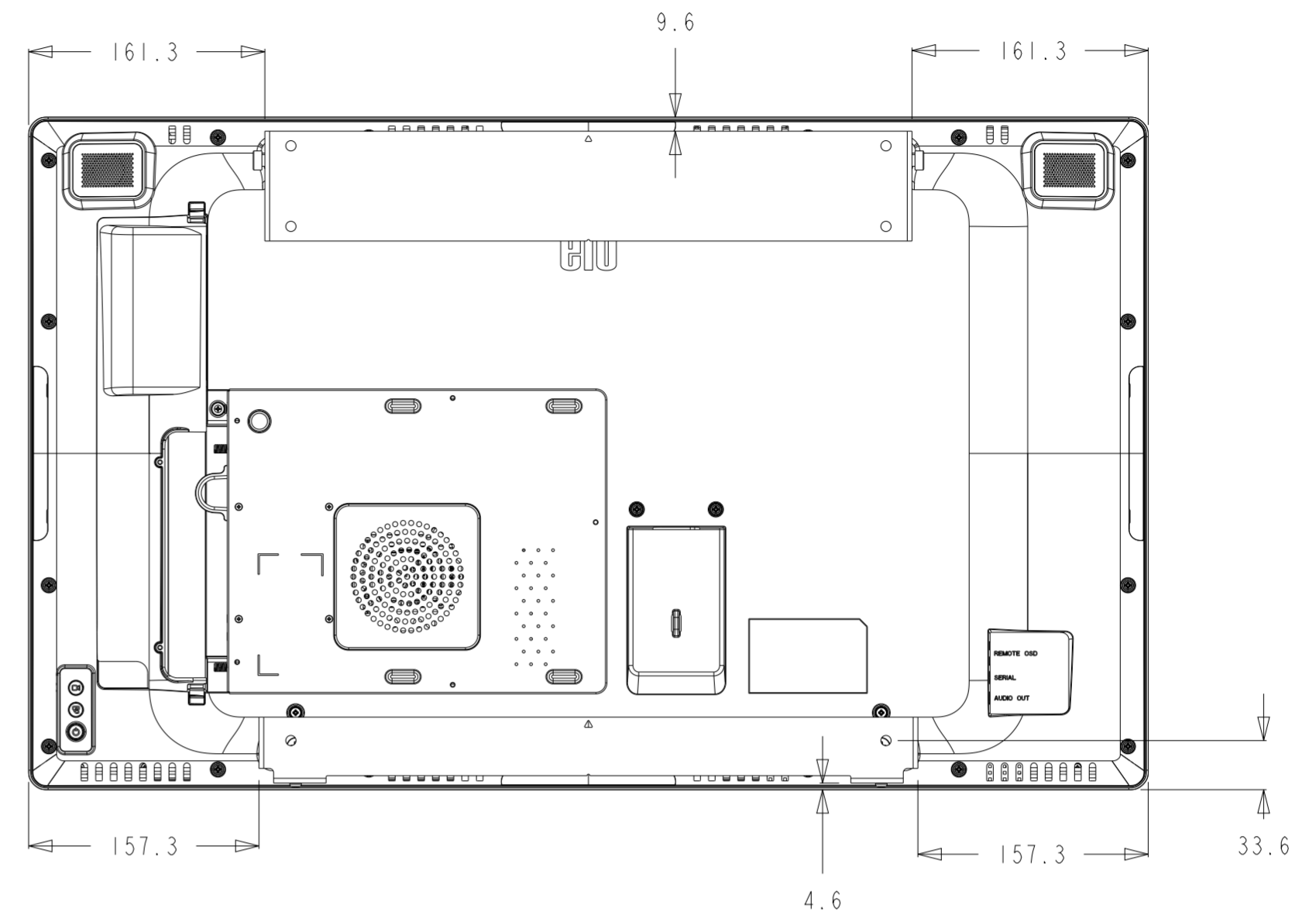
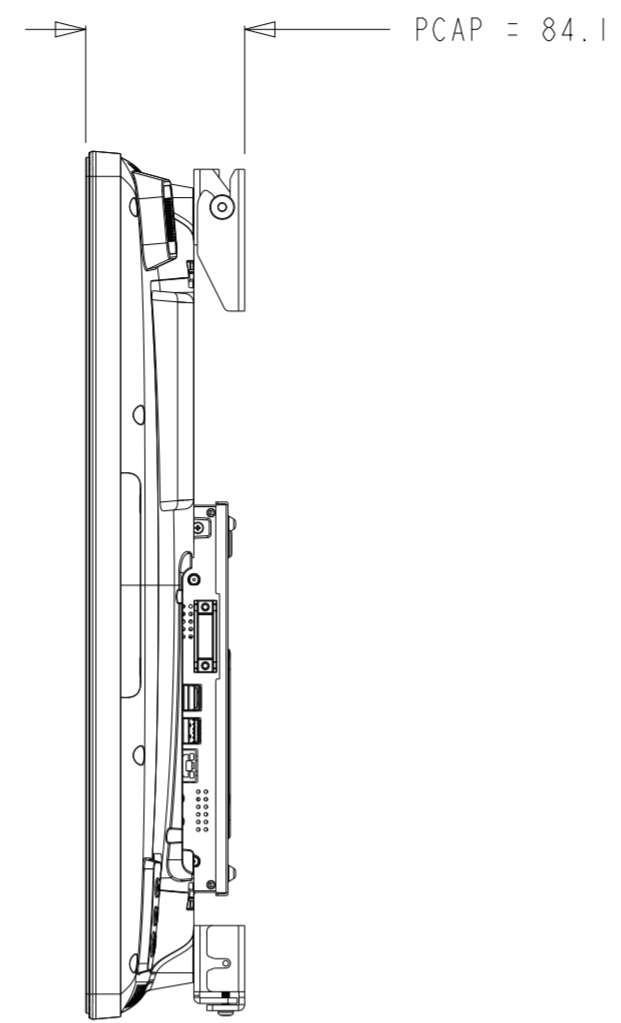
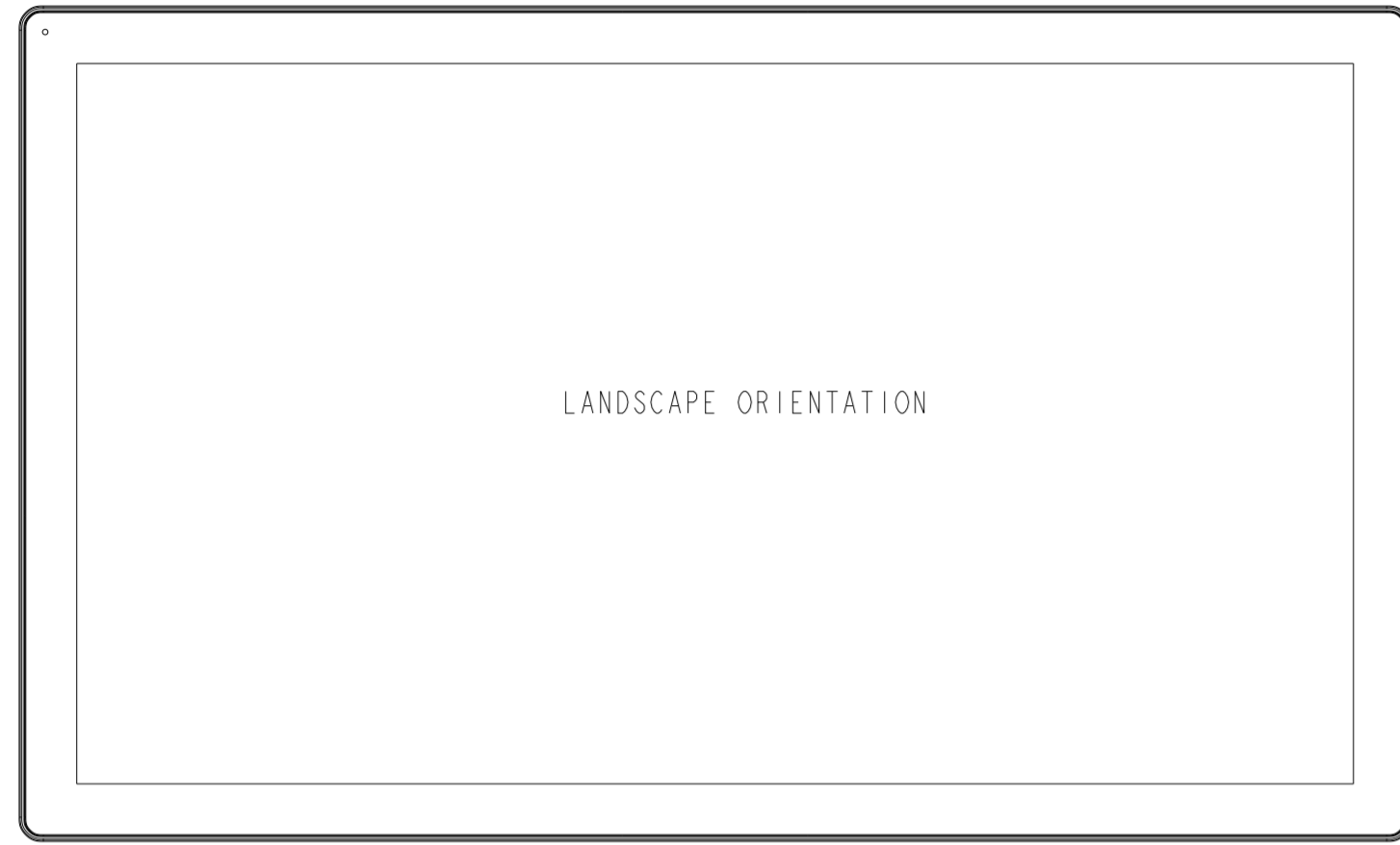

OPTIONAL LOW-PROFILE WALLMOUNT KIT P/N E721949  
 PURCHASED SEPARATELY, CUSTOMER ASSEMBLED

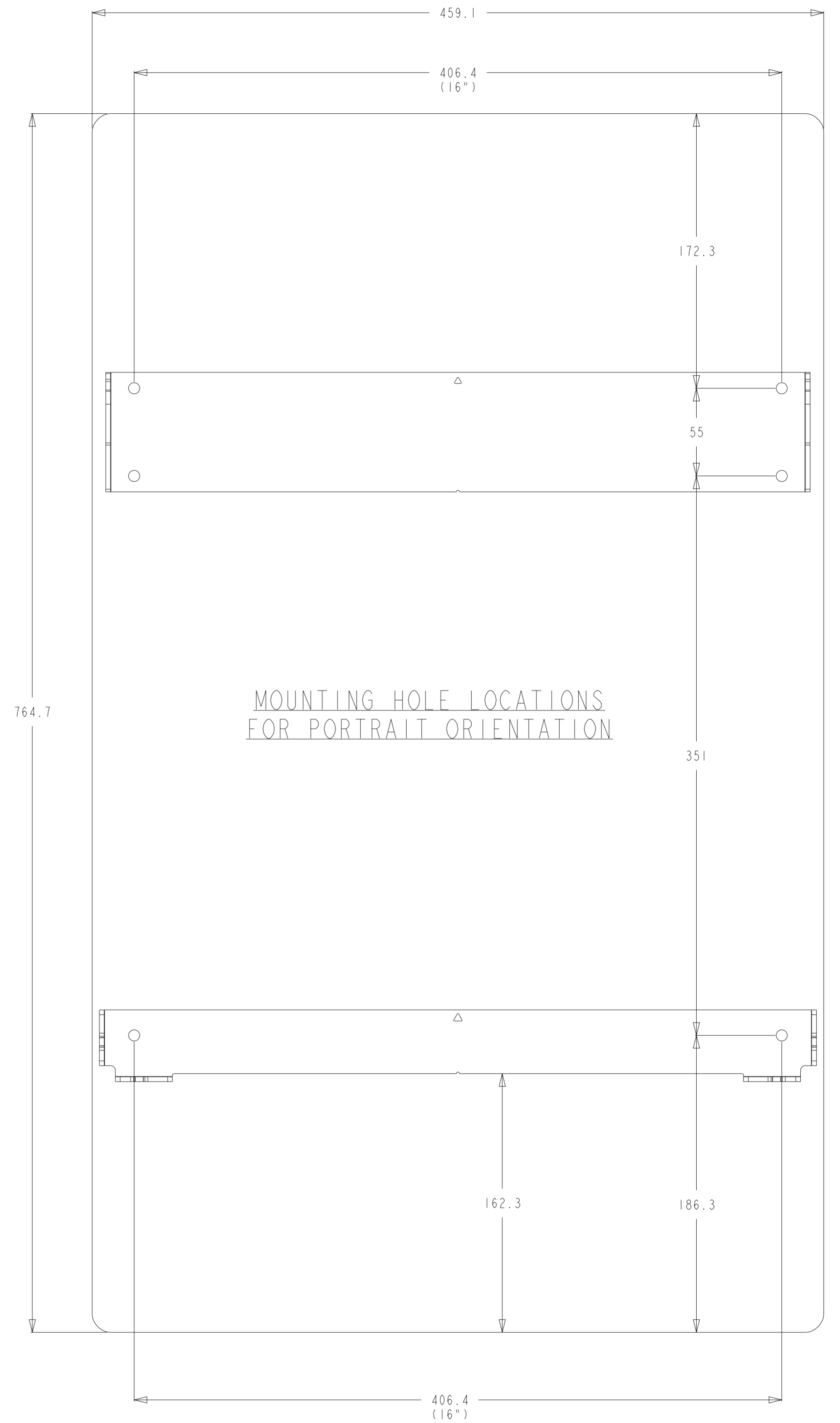
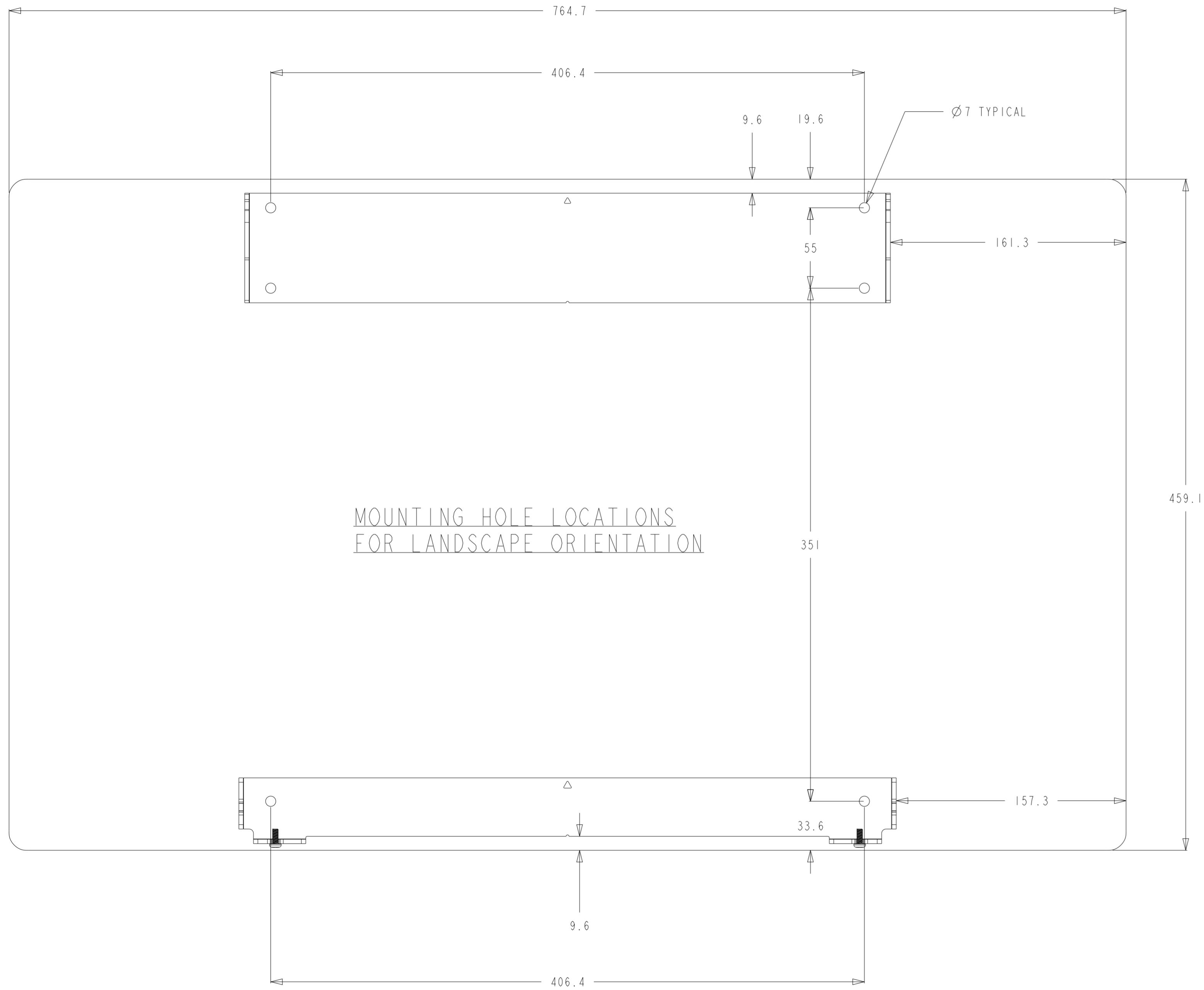

OPTIONAL STAND KIT P/N E722153  
 PURCHASED SEPARATELY, CUSTOMER ASSEMBLED  
 NOTE: STAND DOES NOT SUPPORT PORTRAIT ORIENTATION

