

Contents for Kit: E990654, Pro-style EMV cradle kit for Wallaby Pro self-service stands, compatible with Ingenico Lane7000

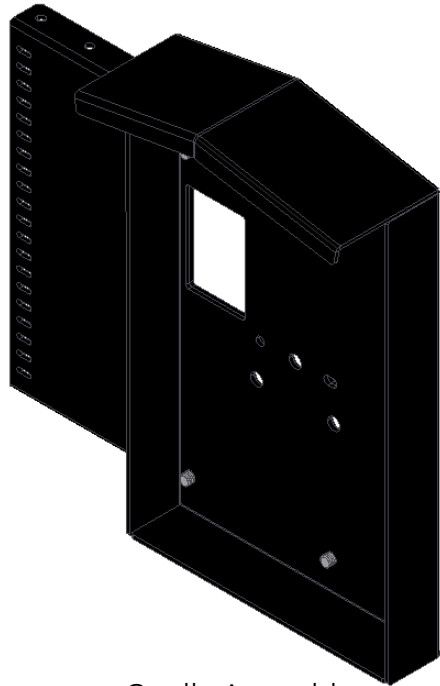

Cradle Assembly
Qty. 1

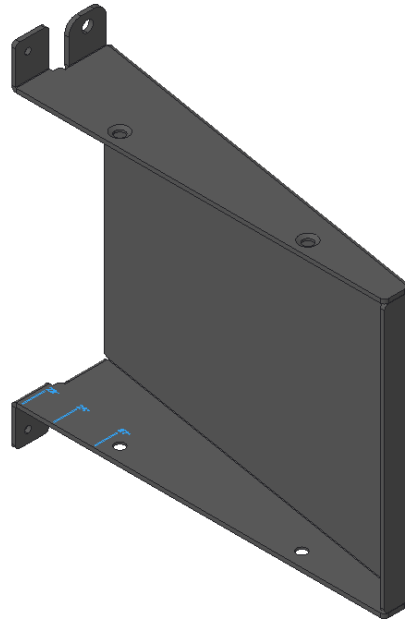

Arm
Qty. 1

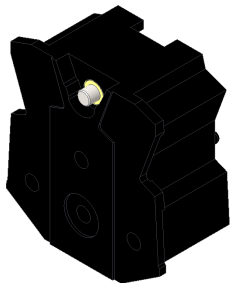

Universal Mount
Qty. 1

Hardware		
Pan Head Screws	Qty.4	Screw, M4x8, Pan Head, Cross Recess, Black
Flat Head Screws	Qty.7	Screw, M4x6, Flat Head, 120°, Cross Recess, Black

1

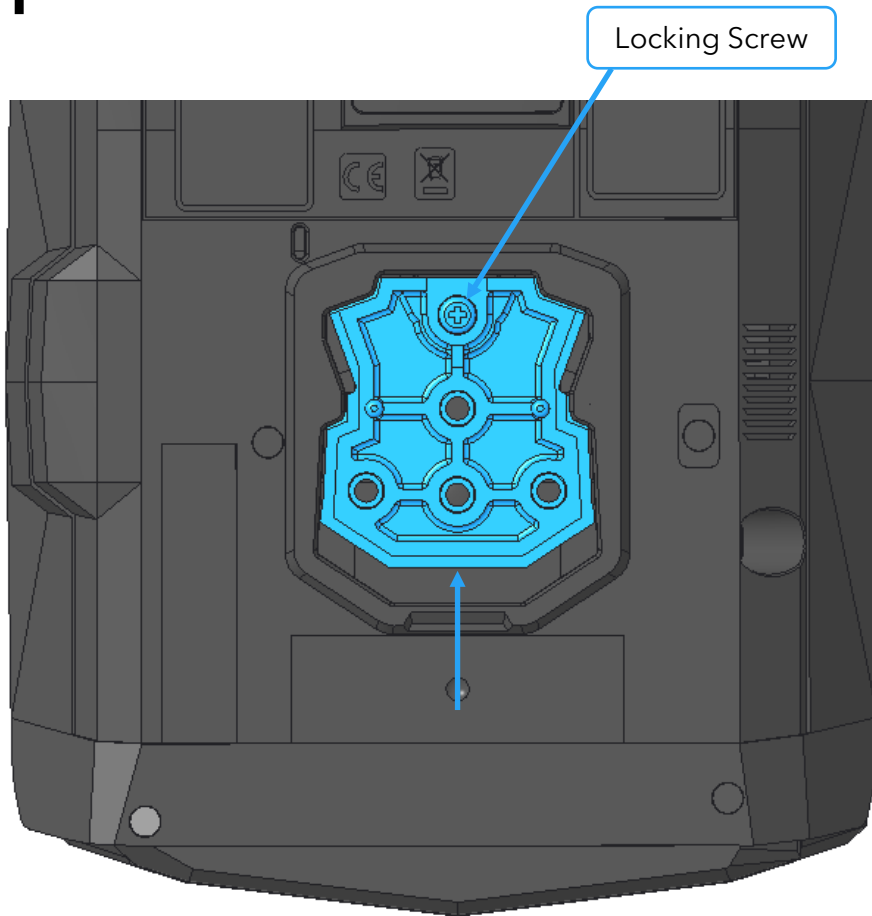

Assemble universal mount to bottom of EMV terminal by sliding upwards as shown.

Tighten locking screw.

2



Assemble EMV terminal cable (not included) as shown.

3



Feed EMV terminal cable through hole in cradle assembly as shown. Stow cable ferrite in cavity as shown.

4

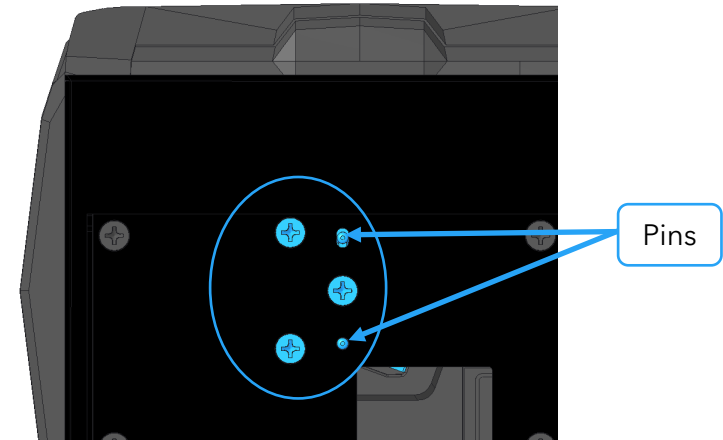
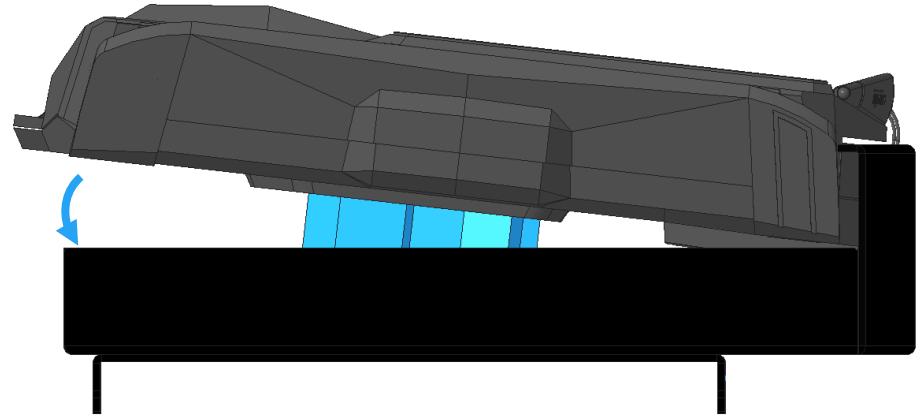

Assemble EMV terminal into cradle assembly by tilting down as shown, while pulling excess cable .

Ensure two pins from universal mount are engage with holes in cradle assembly. Fasten universal mount to cradle assembly by installing three screws from "Flat Head Screws" bag.

5

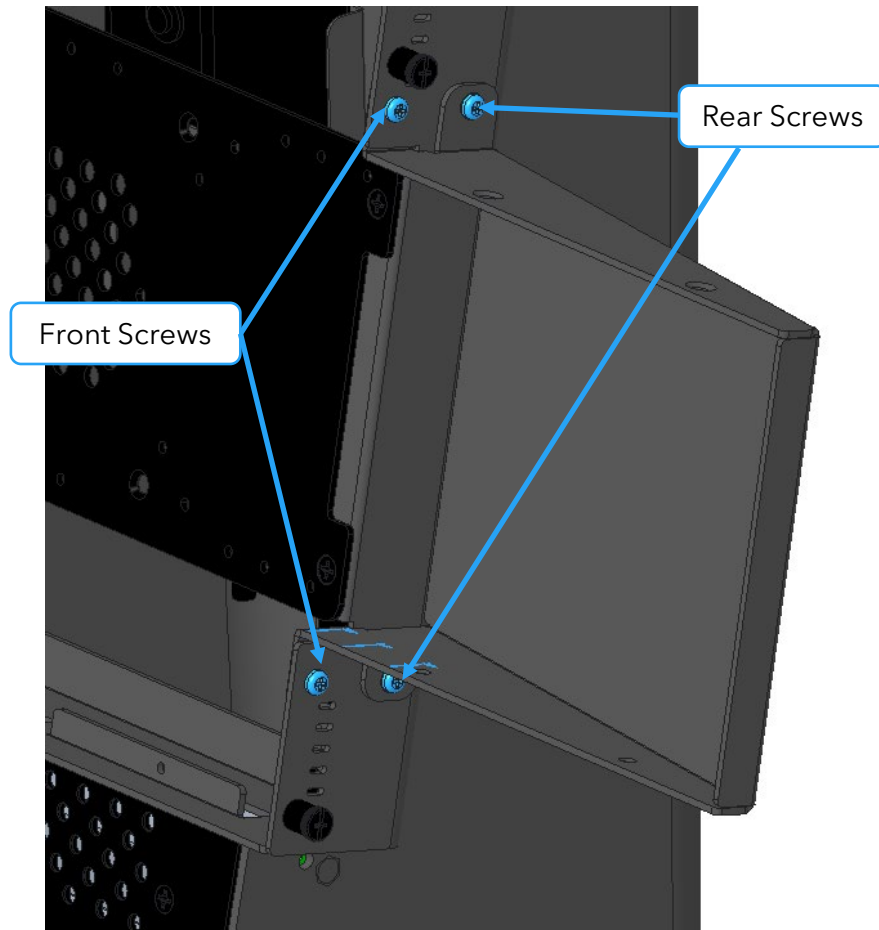

Assemble arm to stand, ensuring front tabs are inside opening in display bracket. Partially install two rear screws (from "Pan Head Screws" bag). Install two front screws from "Pan Head Screws" bag. Fully tighten rear screws.

6

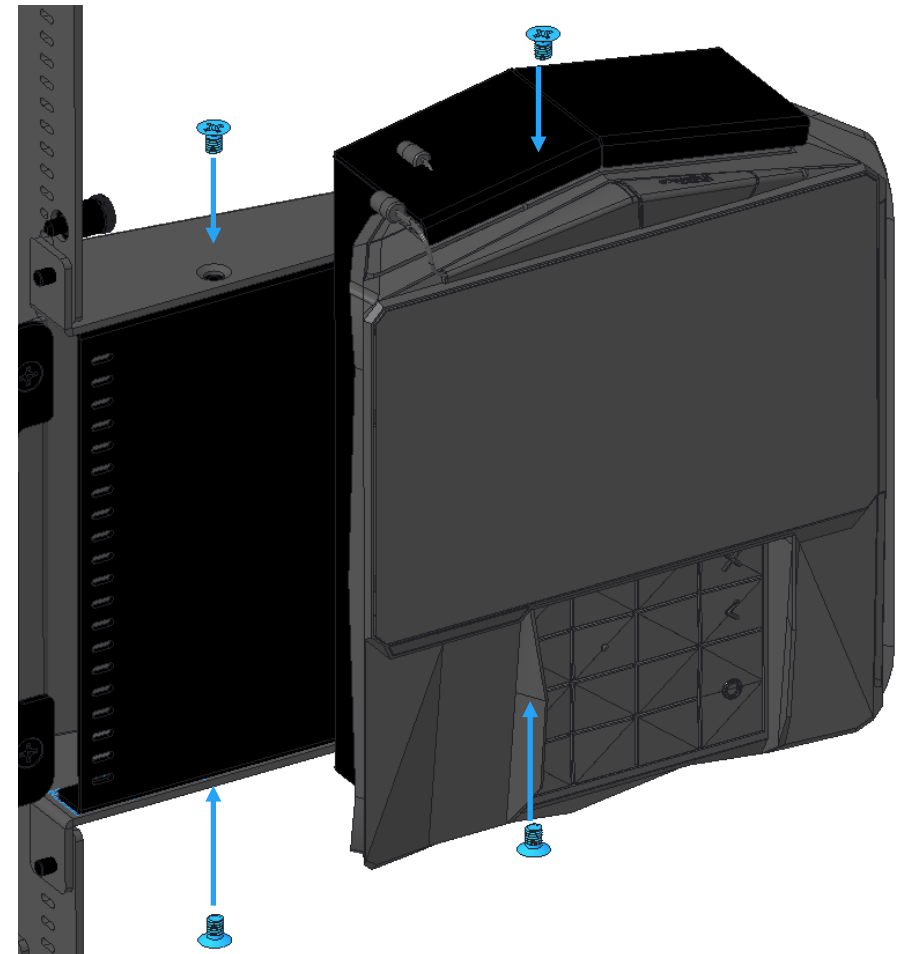

Assemble cradle assembly to arm. Align left edge of cradle assembly with marking corresponding to display size (22"/24"/27").

Fasten cradle assembly using four screws from "Flat Head Screws" bag.

7

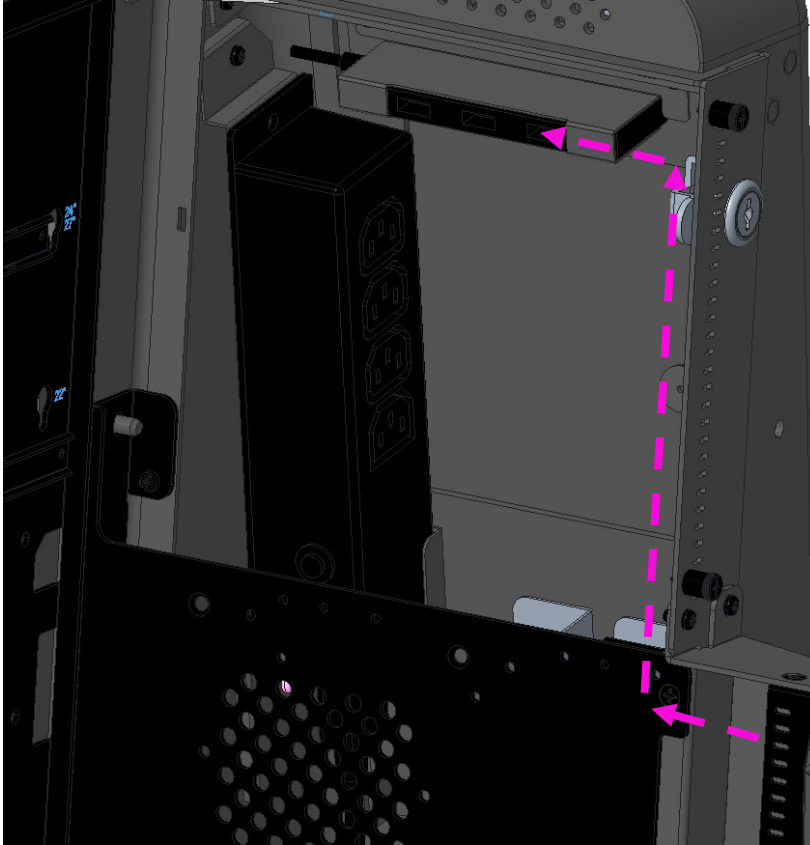

Route **USB cable** from EMV terminal to USB hub.

8

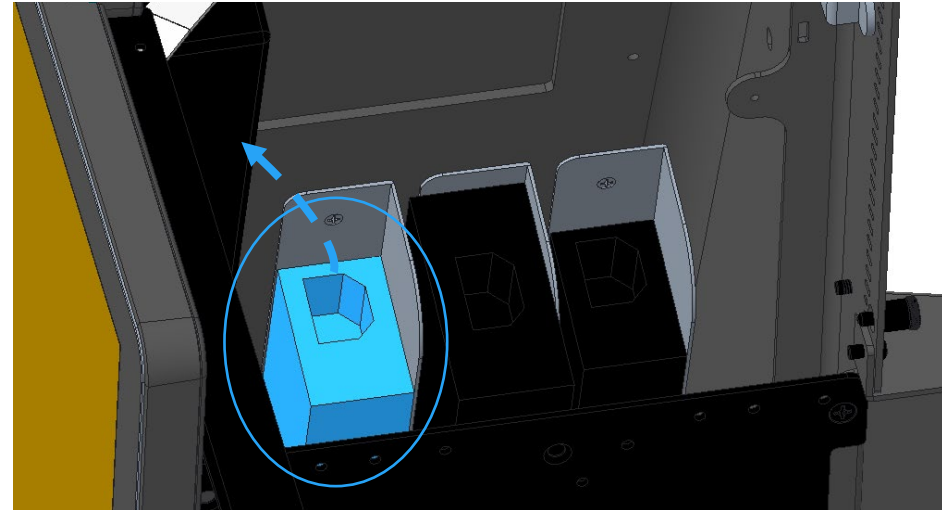

If EMV terminal includes a DC power supply, remove AC cable from power supply, and install power supply in left bay as shown. Secure power supply with velcro strap. Use a 0.3m power cable from the Wallaby Pro accessories (either C5 or C13, depending on the printer power supply) to connect the power supply to the power strip.

If EMV terminal includes wall-wart style adapter, an IEC C13 to AC adapter is required. For North America, StarTech P/N **PAC100** is recommended.



Return to Wallaby Pro assembly instructions to complete assembly.

Learn more about Elo at [EloTouch.com](https://www.elotouch.com).

Americas

Tel +1 408 597 8000
EloSales.NA@elotouch.com

Europe (EMEA)

Tel +32 16 930 136
EMEA.sales@elotouch.com

Asia Pacific

Tel +86 (21) 3329 1385
EloAsia@elotouch.com

The information in this document is subject to change without notice. Elo Touch Solutions, Inc. and its Affiliates (collectively “Elo”) makes no representations or warranties with respect to the contents herein, and specifically disclaims any implied warranties of merchantability or fitness for a particular purpose. Elo reserves the right to revise this publication and to make changes from time to time in the content hereof without obligation of Elo to notify any person of such revisions or changes.

No part of this publication may be reproduced, transmitted, transcribed, stored in a retrieval system, or translated into any language or computer language, in any form or by any means, including, but not limited to, electronic, magnetic, optical, chemical, manual, or otherwise without prior written permission of Elo Touch Solutions, Inc.

Elo, the Elo logo and Wallaby are either trademarks or registered trademarks of Elo Touch Solutions, Inc.