

ēlo



USER MANUAL

Elo Touch Solutions 2401LM Touchmonitor

SW200127 Rev A

No part of this publication may be reproduced, transmitted, transcribed, stored in a retrieval system, or translated into any language or computer language, in any form or by any means, including, but not limited to, electronic, magnetic, optical, chemical, manual, or otherwise without prior written permission of Elo Touch Solutions, Inc.

Disclaimer

The information in this document is subject to change without notice. Elo Touch Solutions, Inc. and its Affiliates (collectively "Elo") makes no representations or warranties with respect to the contents herein, and specifically disclaims any implied warranties of merchantability or fitness for a particular purpose. Elo reserves the right to revise this publication and to make changes from time to time in the content hereof without obligation of Elo to notify any person of such revisions or changes.

Trademark Acknowledgments

AccuTouch, CarrollTouch, Elo, Elo (logo), Elo Touch, Elo Touch Solutions, Elo TouchSystems, IntelliTouch, iTouch, SecureTouch, TouchTools and VuPoint are trademarks of Elo and its Affiliates. Windows is a trademark of Microsoft Corporation.

Warnings and Cautions



Warning

- Danger - Explosion hazard. Do not use in the presence of flammable anesthetics, and other flammable materials.
- To prevent fire or shock hazards, do not immerse the unit in water or expose it to rain or moisture.
- Do not use the unit with an extension cord receptacle or other outlets unless the prongs of the power cord can be fully inserted.
- RISK OF ELECTRICAL SHOCK - DO NOT OPEN. To reduce the risk of electrical shock, DO NOT remove the back of the equipment or open the enclosure. No user-serviceable parts are inside. Refer servicing to qualified field service engineers only.
- Uninsulated voltage within the unit may have sufficient magnitude to cause electrical shock.
- Avoid contact with any part inside the unit.
- This device complies with the electromagnetic emission and immunity standards and is limited to the standards that are listed on pages 6 and 26. Other devices which are not designed to withstand emission levels as specified in the medical device standards may be susceptible to interference from this device. Subjecting the device to conditions beyond the rated performance capabilities may result in emissions in excess of the standard. If it is determined that this device produces electromagnetic or other interference it must be disconnected from power until the cause of the problem has been determined and resolved. If it is determined that this device is functioning improperly due to electromagnetic and other interference it must be disconnected from power until the cause of the problem has been determined and resolved.
- Elo Touch Solutions recommends that after its useful life (or after sustaining unrepairable damage), customers dispose of the Touchmonitor and its power supply in an environmentally sound manner. Acceptable methods include the reuse of parts or whole products and the recycling of products, components, and materials. Please consult and obey national state, and local laws and ordinances governing the safe disposal of electronic equipment.
- To avoid risk of electric shock, this equipment must only be connected to supply mains with protective earth.

This product consists of devices that may contain mercury, which must be recycled or disposed of in accordance with local, state, or federal laws.

Caution

- Power cord is used as a disconnection device. To de-energize equipment, disconnect the power cord.
- This unit must follow the national requirement and local state laws to dispose unit.
- Before connecting the cables to your Elo Touchmonitor, make sure all components are powered OFF.
- Only approved components complying with IEC60601-1 series can be connected to 2401LM touch monitor for Healthcare Applications in Patient Environment. The use of ACCESSORY equipment not complying with the equivalent safety requirements of this equipment may lead to a reduced safety of the resulting system. Consideration relating to the choices of accessory equipment should include: Use of accessory in the patient environment. Evidence that the safety certification of the accessory has been performed in accordance to the appropriate IEC 60601-1 and/or IEC 60601-1-1 harmonized national standard.
- For continued safety
 - This unit only complies to the above standards if used with a medical grade power cord.
 - A medical grade power supply, such as the one specified, is required for use in a medical application.
- Please do not touch the patient and the Touchmonitor output connector at the same time.

Note:



- This symbol alerts the user to important information concerning the operation and maintenance of this unit, which should be read carefully to avoid problems.



- This symbol means DC Current.



- This symbol means ON/OFF stand-by switch.

Medical and Healthcare Application Disclaimer:

It is the sole responsibility of any person intending to commercialize, market or use any of Elo Touch Solutions, Inc. or its family of companies ("Elo") products for medical or healthcare applications to ensure that such product is adequate and appropriate for the person's intended use and complies with all applicable laws, regulations, codes and standards including but not limited to the European Union Medical Device Directive, United States Federal Food, Drug, and Cosmetic Act, regulations of the United States Food and Drug Administration (FDA), and for obtaining and maintaining any required regulatory approvals including but not limited to any required market clearances. Elo has not sought nor received any rulings from the FDA or any other federal, state, or local government agency or notified body as to the safety, effectiveness or appropriateness of its product for such applications. Persons intending to evaluate or use Elo's product for medical or healthcare purposes must rely on their own medical and legal judgment without any representation on the part of Elo.

Classification



With respect to electrical shock, fire in accordance with ANSI/AAMI ES60601-1:2005 and CAN/CSA C22.2 No. 60601-1-08

This Touchmonitor is a Class I (GROUNDED) DEVICE.

These Touchmonitors are classified NO APPLIED PARTS EQUIPMENT.

Protection against harmful ingress of water:

INGRESS PROTECTION (IPX1)

This Touchmonitor shall be classified as ORDINARY EQUIPMENT, not intended or evaluated for use in the presence of flammable anesthetic mixture with air, oxygen, or nitrous oxide.

Mode of Operation: CONTINUOUS OPERATION.

Environmental conditions for transport and storage

Temp.	Operating	0°C to 40°C
	Storage / Transportation	-20°C to 65°C

Humidity (non-condensing)

	Operating	20% to 80%
	Storage / Transportation	10% to 90%
Altitude	Operating	0 to 3,000m
	Storage / Transportation	0 to 12,192m

2401LM Touchmonitor for Healthcare Applications is intended for general use in hospital environment for data collection and display for reference. It shall not be used with life-supporting system.

European Standards and Classifications

Standards: EN 60601-1-2: 2007

The EMC limits and test methods are referred to the following standards:

Emission:

CISPR11:2009+A1:2010 ED. 5.1(Grp I, Class B)

AS/NZS CISPR 11: 2011, Grp. 1, Class B

EN 61000-3-2: 2006 +A1: 2008+A2: 2009, Class D

IEC 61000-3-3: 2008

Immunity

IEC61000-4-2:2008 ED.2.0

IEC61000-4-3:2006+A1:2007 +A2:2010ED.3.2

IEC 61000-4-4: 2012 ED.3.0

IEC 61000-4-5: 2005 ED.2.0

IEC 61000-4-6: 2008 ED.3.0

IEC 61000-4-8: 2009 ED.2.0

IEC 61000-4-11: 2004 ED.2.0

**Guidance and manufacturer's declaration-electromagnetic immunity for all
EQUIPMENT AND SYSTEMS**

Guidance and manufacturer's declaration-electromagnetic emissions		
The 2401LM Touchmonitor for Healthcare Applications is intended for use in the electromagnetic environment specified below. The customer or the user of the 2401LM Touchmonitor for Healthcare Applications should assure that it is used in such an environment.		
Emissions test	Compliance	Electromagnetic environment-guidelines
RF emissions CISPR 11	Group 1	The 2401LM Touchmonitor for Healthcare Applications uses RF energy only for its internal function. Therefore, its RF emissions are very low and are not likely to cause any interference in nearby electronic equipment.
RF emissions CISPR 11	Class A	The 2401LM Touchmonitor for Healthcare Applications is suitable for use in all establishments other than domestic and those directly connected to a low voltage power supply network which supplies buildings used for domestic purposes.
Harmonics emissions IEC 61000-3-2	Class D	
Voltage fluctuations/flicker emissions IEC 61000-3-3	Complies	

Guidance and manufacturer's declaration-electromagnetic immunity for all EQUIPMENT AND SYSTEMS

Guidance and manufacturer's declaration-electromagnetic immunity			
The 2401LM Touchmonitor for Healthcare Applications is intended for use in the electromagnetic environment specified below. The customer, or the user of the 2401LM Touchmonitor for Healthcare Applications, should assure that it is used in such an environment.			
Immunity Test Level	IEC 60601	Compliance Level	Electromagnetic Environment - Guidelines
Electrostatic Discharge (ESD) IEC 61000-4-2	± 6 kV contact ± 8 kV air	± 6 kV contact ± 8 kV air	Floors should be wood, concrete or ceramic tile. If floors are covered with synthetic material, the relative humidity should be at least 30%.
Electrical Fast Transient/Burst IEC 61000-4-4	± 2 kV for power supply lines ± 1 kV for input/output lines	± 2 kV for power supply lines ± 1 kV for input/output Lines	Mains power quality should be that of a typical commercial or hospital environment.
Surge IEC 61000-4-5	± 1 kV line(s) to line(s) ± 2 kV line(s) to earth	± 1 kV line(s) to line(s) ± 2 kV line(s) to earth	Mains power quality should be that of a typical commercial or hospital environment.
Voltage Dips, Short Interruption and Voltage Variations on Power Supply Input Lines IEC 61000-4-11	<5% UT (>95% dip in UT) for 0.5 cycle 40% UT (60% dip in UT) for 5 cycles 70% UT (30% dip in UT) for 25 cycles <5% UT (>95% dip in UT) for 250 cycles	<5% UT (>95% dip in UT) for 0.5 cycle 40% UT (60 % dip in UT) for 5 cycles 70% UT (30% dip in UT) for 25 cycles <5% UT (>95% dip in UT) for 250 cycles	Mains power quality should be that of a typical commercial or hospital environment. If the user of the 2401LM Touchmonitor for Healthcare Applications requires continued operation during power mains interruptions, It is recommended that the 2401LM Touchmonitor for Healthcare Applications be powered from an uninterruptible power supply or a battery.
Power Frequency (50/60 Hz) Magnetic Field IEC 61000-4-8	3 A/m	3 A/m	Power frequency magnetic fields should be at levels characteristic of a typical location in a typical commercial or hospital environment.
NOTE UT is the A.C. mains voltage prior to application of the test level.			

Guidance and manufacturer's declaration-electromagnetic immunity for all EQUIPMENT AND SYSTEMS that are not LIFE-SUPPORTING

Guidance and manufacturer's declaration-electromagnetic immunity

The 2401LM Touchmonitor for Healthcare Applications is intended for use in the electromagnetic environment specified below. The user of the 2401LM Touchmonitor for Healthcare Applications should assure that it is used in such an environment.

Immunity Test	IEC 60601 Test Level	Compliance Level	Electromagnetic Environment-Guidelines
<p>Conducted RF</p> <p>Radiated RF IEC 61000-4-3</p>	<p>3 Vrms</p> <p>3 V/m 80 MHz to 2.5 GHz</p>	<p>3 Vrms</p> <p>3 Vrms</p>	<p>Portable and mobile RF communications equipment should be used no closer to any part of the 2401LM Touchmonitor for Healthcare Applications and should assure that it is used in such an environment, including cables, than the recommended separation distance calculated from the equation applicable to the frequency of the transmitter. Recommended separation distance</p> $d=1.2\sqrt{P}$ <p>$d=1.2\sqrt{P}$ 80MHz to 800 MHz</p> $d=2.3\sqrt{P}$ 800 MHz to 2.5GHz <p>where P is the maximum output power rating of the transmitter in watts (W) according to the transmitter manufacturer and d is the recommended separation distance in metres(m)</p> <p>Field strengths from fixed RF transmitters, as determined by an electromagnetic site survey¹, should be less than the compliance level in each frequency range². Interference may occur in the vicinity of equipment marked with the following symbol:</p> 

NOTE 1: At 80 MHz and 800 MHz, the higher frequency range applies.

NOTE 2: These guidelines may not apply in all situations. Electromagnetic propagation is affected by absorption and reflection from structures, objects and people.

3. Field strengths from fixed transmitters, such as base stations for radio (cellular/cordless) telephones and land mobile radios, amateur radio, AM and FM radio broadcast and TV broadcast cannot be predicted theoretically with accuracy. To assess the electromagnetic environment due to fixed RF transmitters, an electromagnetic site survey should be considered. If the measured field strength in the location in which the 2401LM Touchmonitor for Healthcare Applications is used exceeds the applicable RF compliance level above, the 2401LM Touchmonitor for Healthcare Applications should be observed to verify normal operation. If abnormal performance is observed, additional measures may be necessary, such as reorienting or relocating the 2401LM Touchmonitor for Healthcare Applications.

4. Over the frequency range 150 kHz to 80 MHz, field strengths should be less than 3 Vrms.

Recommended separation distances between portable and mobile RF communications equipment and the 2401LM Touchmonitor for Healthcare Applications for all EQUIPMENT AND SYSTEMS that are not LIFE-SUPPORTING

The 2401LM Touchmonitor for Healthcare Applications is intended for use in an electromagnetic environment in which radiated RF disturbances are controlled. The customer or the user of the 2401LM Touchmonitor for Healthcare Applications can help prevent electromagnetic interference by maintaining a minimum distance between portable and mobile RF communications (equipment) and the 2401LM Touchmonitor for Healthcare Applications as recommended below according to the maximum output power of the communications equipment.

Rated Maximum Output Power of Transmitter (W)	Separation Distance According to Frequency of Transmitter m		
	150 kHz to 80 MHz $d=1.2\sqrt{P}$	80MHz to 800 MHz $d=1.2\sqrt{P}$	800 MHz to 2.5 GHz $d=2.3\sqrt{P}$
0.01	0.12	0.12	0.23
0.1	0.37	0.37	0.74
1	1.2	1.2	2.3
10	3.7	3.7	7.4
100	12	12	23

For transmitters rated at a maximum output power not listed above, the recommended separation distanced in metres (m) can be estimated using the equation applicable to the frequency of the transmitter, where P is the maximum output power rating of the transmitter in watts (W) according to the transmitter manufacturer.

NOTE 1: At 80 MHz and 800 MHz, the separation distance for the higher frequency range applies.

NOTE 2: These guidelines may not apply in all situations. Electromagnetic propagation is affected by absorption and reflection from structures, objects and people.

Table of Contents

Chapter 1: Introduction..... 12

Chapter 2: Installation..... 13

Chapter 3: Mounting 17

Chapter 4: Operation..... 19

Chapter 5: Technical Support 23

Chapter 6: Safety & Maintenance 24

Chapter 7: Regulatory Information 26

Chapter 8: Warranty Information 30

Index 31

Chapter 1: Introduction

Product Description

Your new touch monitor combines Elo Touch Solutions' reliable performance with the latest developments in touch technology and display design. This combination of features creates a natural flow of information between a user and the Touchmonitor.

This Touchmonitor incorporates a 8-bit color, active matrix thin-film-transistor LCD panel to provide high quality display performance. Its Full HD resolution of 1920x1080 is suitable for displaying graphics and images. Its LED backlight significantly reduces power consumption and eliminates mercury (compared to CCFL-backlit panels). Other features that enhance this LCD monitor's performance are Plug & Play compatibility, built-in speakers and headphone output capability, on-screen display (OSD) controls, and a family of peripherals including webcam and magnetic stripe reader.

Precautions

Follow all warnings, precautions and maintenance as recommended in this user manual to maximize the life of your unit and prevent risks to user safety. See the Safety & Maintenance chapter for more information.

This manual contains information that is important for the proper setup and maintenance of the unit. Before setting up and powering on your new touch monitor, read through this manual, especially the Installation, Mounting, and Operation chapters.

Chapter 2: Installation

Unpacking the Touch monitor

Open the carton and verify the following items are present:

- Touchmonitor with protective sheet for its face
- Elo TouchTools CD
- Quick Install Guide
- DVI cable
- VGA cable
- USB cable
- AC-DC power adapter
- AC Power Cable
- Audio Cable
- Serial Cable

Connector Panel & Interfaces

Remove the cable cover on the back of the unit to access the Touchmonitor's connector panel.

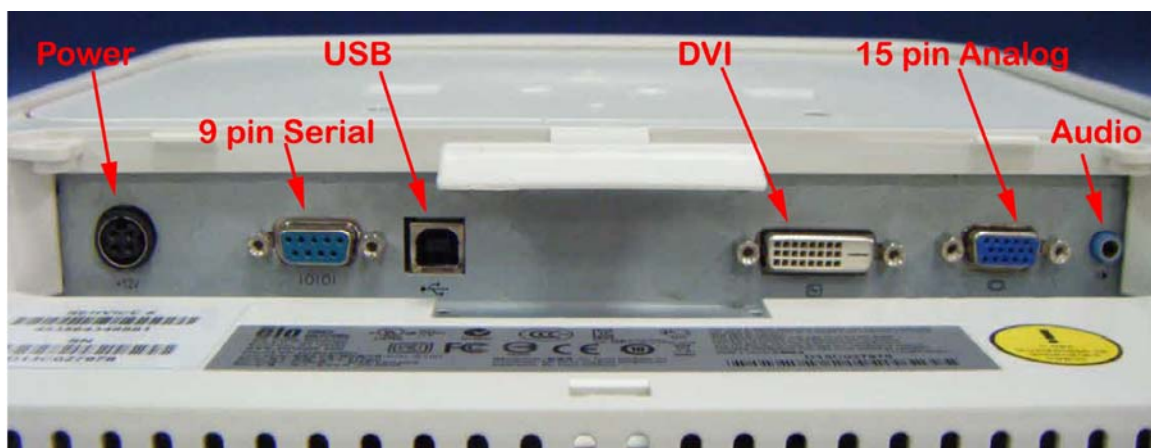

Touchmonitor Connections

1. Connect the DVI or VGA video cables between the monitor's DVI/VGA input connectors and your DVI/VGA video source, respectively. Tighten the video cable's screws for best performance.
2. Connect the USB touch cable between the monitor's USB connector and your PC's USB port.
3. Connect the audio cable between the monitor's Audio In jack and your audio source.
4. Select the correct power cable for your region. Connect the cable between the AC power source and the power adapter's input connector. Connect the power adapter's DC output connector to the monitor's input power jack.

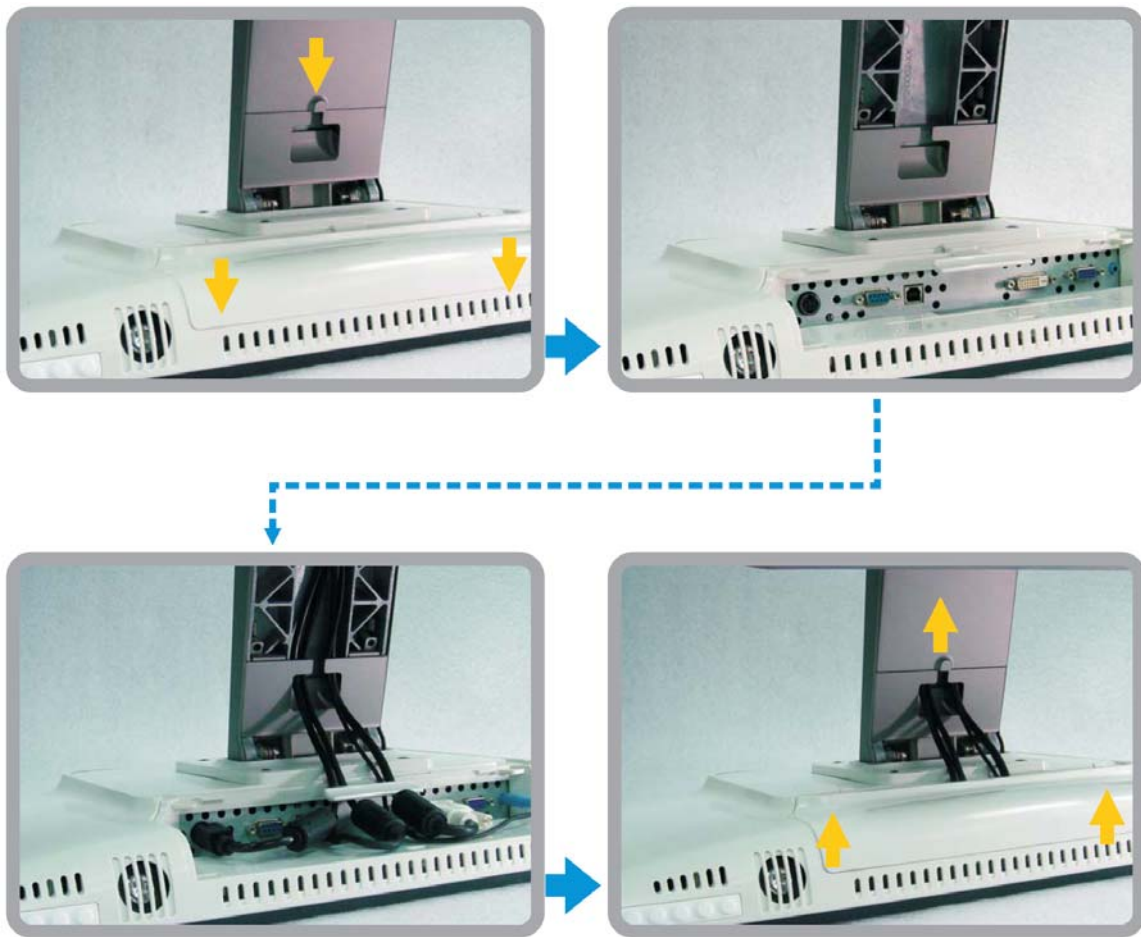

5. **Be sure to reinstall the cable cover and secure with appropriate screws.** Cables can be routed inside the stand – remove and replace the stand cable cover for access and routing.
6. The Touchmonitor ships in an OFF state. Press the power button to turn it on.

Installing the Touch Technology Software Drivers

Some software installation is required for your Touchmonitor to work with your computer.

The drivers for the Windows 7, XP, Vista, WePOS, and 32-bit Server 2003 operating systems are provided with your Touchmonitor on a CD.

Visit the Elo Touch Solutions website www.elotouch.com for:

- The most up-to-date touch driver versions
- Additional touch driver information
- Detailed touch driver installation guides
- Touch drivers for other operating systems

Download the appropriate driver for your application and follow the onscreen prompts.

For Windows XP, Vista, Server 2003, Server 2008, and WEPOS installations, install the “USB Touchscreen Drivers” when prompted.

If you do not have the internet available, insert the Elo TouchTools CD into your computer’s CD-ROM drive. The CD should automatically run the Elo TouchTools application. Select “Install Driver for This computer”:



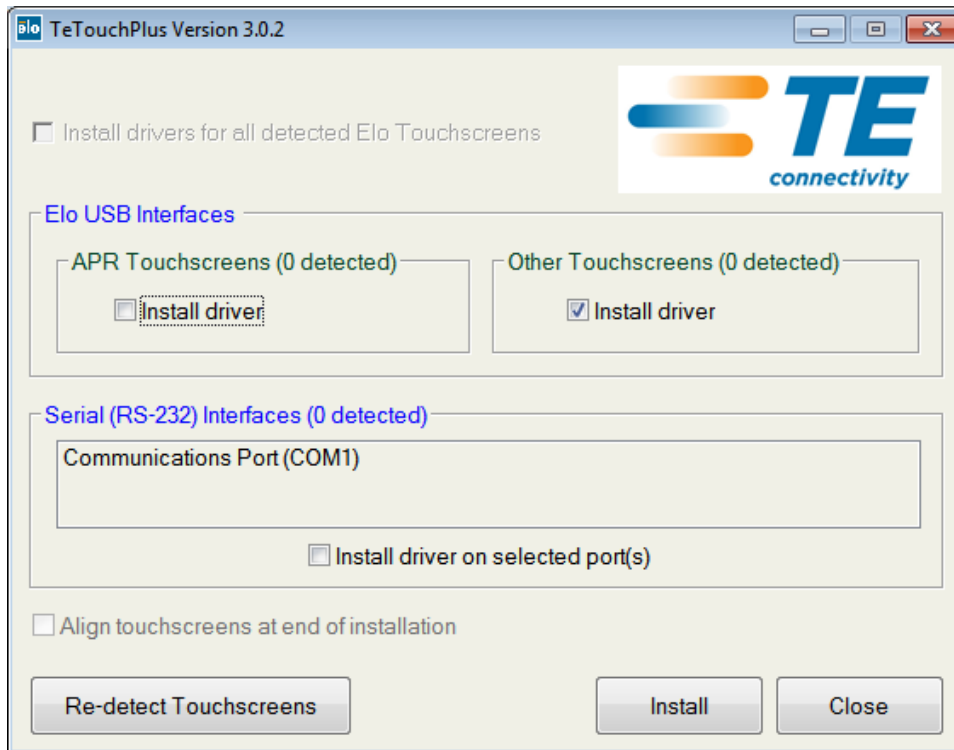

For Windows 7 installations, check the “Install driver” box under “Elo USB Interfaces – Other Touchscreens”

After accepting the end-user license agreement, the drivers will finish installing.

Reboot your computer after the install is complete.

Chapter 3: Mounting

General Mounting Information

The OSD text can be rotated through the OSD menu to better suit your mounting orientation.

The holes located on the top and bottom of the Touchmonitor case are for ventilation. Do not block, cover, or insert anything inside the ventilation slots.

Rear VESA Mount

A four-hole 100x100mm mounting pattern for M4 screws is provided on the rear of the monitor. Remove the stand using a Phillips screwdriver to access this mounting interface. The VESA FDMI-compliant mounting is coded: VESA MIS-D, 100, C

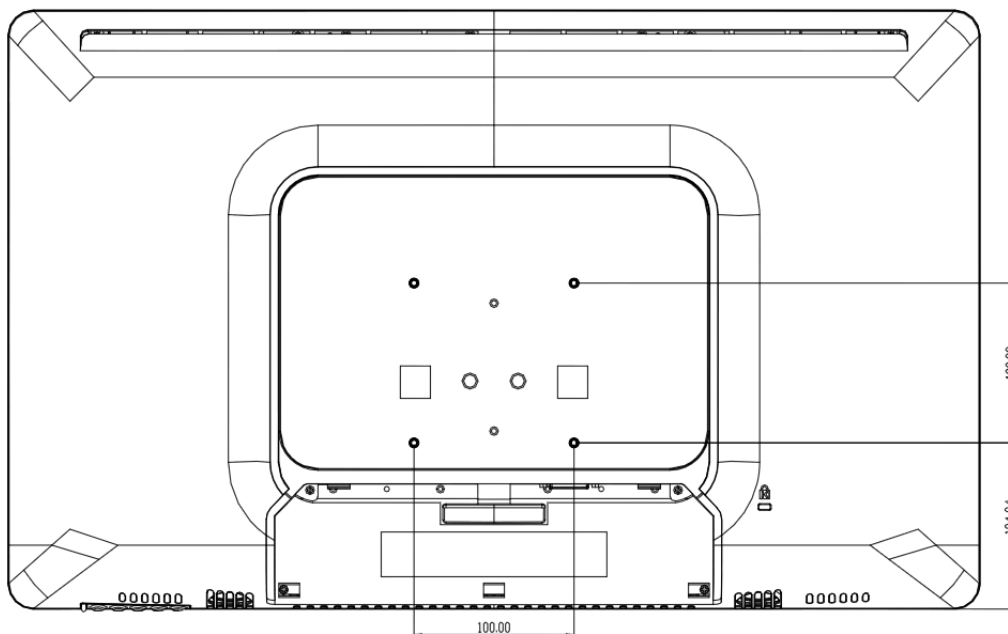

Stand Mounting

Threaded through-holes are provided on the bottom of the stand base for mounting or securing.

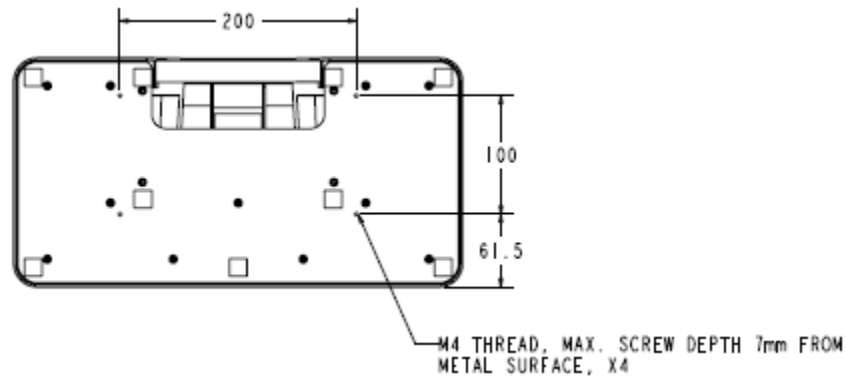

VESA Mounting Options

The following companies provide VESA mounting devices compatible with your touch monitor :

GCX

800-228-2555

707-773-1100

www.gcx.com

Ergotron

800-888-8458

651-681-7600

www.ergotron.com

Innovative Office Products

800-524-2744

610-253-9554

www.innov-office-prod.com

MRI

800-688-2414

www.mediarecovery.com

Chapter 4: Operation

Power

To turn the Touchmonitor on or off, press the Touchmonitor power button once.

The Power Status LED on the bottom of the Touchmonitor functions according to the following table:

Touchmonitor/Computer Module status	LED status
OFF	OFF
SLEEP	ORANGE
ON	GREEN

The system consumes low power when in SLEEP and OFF modes. For detailed power consumption specifications, refer to technical specifications on the Elo website <http://www.elotouch.com>

Touching the screen will bring the attached host PC out of SLEEP mode (similar to moving the mouse or pressing a keyboard key).

To improve reliability and reduce wasteful power consumption, disconnect the AC power cable from the power adapter when long periods of disuse are planned.

Touch

Your IntelliTouch Touchmonitor is factory-calibrated and should not need manual calibration (unless the input video is not fully scaled to the native resolution, or the touch experience needs to be calibrated to a specific user).

Video

A display's native resolution is its width and height measured in number of pixels. Generally, for best performance, an image displayed on this monitor will look best when your computer's output resolution matches this monitor's native resolution of 1920x1080.

For computer output resolutions at non-native resolutions, the monitor will scale the video to its panel's native resolution. This involves stretching or compressing the input image as needed in the X- and Y-dimensions to fit the display's native resolution. An unavoidable byproduct of the scaling algorithms is a loss of fidelity when the computer's output video image is scaled by the monitor to fit the display. This loss of fidelity is most apparent when viewing feature-rich images at close distances

(for example images containing small-font text).

Your Touchmonitor will likely not require video adjustments. However, for analog VGA video, variations in video graphic card outputs may require user adjustments through the OSD to optimize the quality of the Touchmonitor’s displayed image. These adjustments are “remembered” by the Touchmonitor. Also, to reduce the need for adjustments for different video mode timings, the monitor correctly scales and displays some of the video industry’s most common video timing modes. Refer to the technical specifications for this monitor at <http://www.elotouch.com> for a list of these Preset Video Modes.

On-Screen Display (OSD)

Four OSD buttons are on the bottom of the monitor. These can be used to adjust various display parameters.



The buttons and their functionality are:

Button	Function when OSD is not displayed:	Function when OSD is displayed:
Menu	Display OSD main menu	Return to previous OSD menu
▲	Display OSD Contrast submenu	Increase value of selected parameter / select next menu item
▼	Display OSD Brightness submenu	Decrease value of selected parameter / select previous menu item
Select	Enter“Auto Adjust” feature(VGA mode only)	Select submenu to enter

Using the OSD buttons controls an on-screen graphical user interface which displays on top of your input video, allowing intuitive adjustment of the following display parameters:

Parameter	Available Adjustment
Contrast	Increase/decrease monitor contrast. Default: best gray-shade performance
Brightness	Increase/decrease monitor brightness. Default: maximum
V-position	Moves the image vertically on the display in single-pixel increments. Default: centered. <i>Only applicable for VGA input video</i>
H-position	Moves the image horizontally on the display in single-pixel increments. Default: centered. <i>Only applicable for VGA input video</i>
Recall Defaults	Selecting “Recall Defaults” restores all factory default settings for OSD-adjustable parameters (except OSD Language) and for Preset Video Mode timings.

Color Temperature	Selects the display's color temperature. The available color temperatures are 9300K, 6500K, 5500K, 7500K, and User Defined. If the User Defined option is selected, the user can change the color temperature by changing individual R, G, and B gains on a scale from 0 to 100. Default: User Defined with R, G, and B all set to 100.
Volume	Adjusts the volume of the internal speakers output.
Sharpness	Adjusts sharpness of the displayed images. Default: no sharpness adjustment
Phase	Allows fine adjustments of the panel's pixel dot clock phase. <i>Only applicable for VGA input video</i>
Clock	Allows fine adjustments of the panel's pixel dot clock. <i>Only applicable for VGA input video</i>
OSD H-position	Moves the OSD horizontally on the display Default: centered.
OSD V-position	Moves the OSD vertically on the display Default: centered.
OSD Timeout	Adjusts how long a period of OSD button inactivity the Touchmonitor will wait before closing the OSD. The adjustable range is between 45 and 255 seconds. Default: 45 seconds
Auto Adjust	Automatically adjusts the system clock to the input analog VGA video signal, affecting the H-position, V-position, Clock, and Phase menu items. <i>Only applicable for VGA input video</i>
OSD Language	Selects which language the OSD information is displayed in. The available languages are: English, French, German, Spanish, Swedish, Italian, Simplified Chinese, Polish, and Japanese. Default: English.
Input Video	Select input video source : VGA or DVI Default: VGA

All Touchmonitor adjustments made through the OSD are automatically memorized as soon as they are entered. This feature saves you from having to reset your choices every time the Touchmonitor is unplugged or powered off and on. If there is a power failure, the Touchmonitor settings will not default to the factory specifications.

OSD and Power Lockouts

Press and hold the “Menu” and “Up” buttons for two seconds to enable/disable the OSD Locking feature. When the OSD Locking is enabled, pressing any of the Menu, Up, Down, or Select keys will have no effect on the system.

Press and hold the “Menu” and “Down” buttons for two seconds to enable/disable the Power Locking feature. When the Power Locking is enabled, pressing the power switch will have no effect on the system.

Audio

When headphones are plugged into the headphone output jack, the internal speakers turn off and audio is played over the headphones.

Volume for the speaker and headphone outputs can be controlled by the OSD.

Chapter 5: Technical Support

If you are experiencing trouble with your Touchmonitor, refer to the following suggestions. If the problem persists, please contact your local dealer or contact Elo Touch Solutions Customer Service.

Solutions to Common Problems

Problem	Suggested Troubleshooting
The Touchmonitor does not respond when turning on the system.	Check that the AC power cable is properly connected. Verify the AC power source is functioning.
Monitor display is dim	Use the OSD to increase the brightness. Use the OSD to increase the contrast.
Monitor display is blank.	If the Power Status LED is blinking, the monitor or Computer Module may be in SLEEP mode. Press any key / move the mouse / touch the Touchscreen to see if the image reappears.
Monitor displays an "Out Of Range" message	Adjust your computer's resolution/timing mode to be within the allowable timing ranges specified for your Touchmonitor (see website for specifications)
Touch functionality doesn't work	Verify your PC has the latest Elo drivers installed. Perform the calibration routine provided with the latest Elo drivers.

Technical Assistance

Visit www.elotouch.com/products for technical specifications for this device

Visit www.elotouch.com/go/websupport for online self-help.

Visit www.elotouch.com/go/contactsupport for technical support.

See this user manual's last page for worldwide technical support phone numbers.

Chapter 6: Safety & Maintenance

Safety

To avoid risk of electric shock, follow all safety notices and do not disassemble the Touchmonitor. They are not user-serviceable.

The slots located on the sides and top of the Touchmonitor case are for ventilation. Do not block or insert anything inside the ventilation slots.

The Touchmonitor ships with a 3-wire, grounding power cord. The power cord plug only fits into a grounded outlet. Do not fit or modify the plug into an outlet that has not been configured for this purpose. Do not use a damaged power cord. Only use the power cord that came with your Elo Touch Solutions Touchmonitor. Use of an unauthorized power cord might invalidate your warranty.

Ensure that your installation is equipped to maintain the specified environmental conditions listed in the Technical Specifications chapter.

Care and Handling

The following tips will help keep your Touchmonitor functioning at an optimal level:

- Disconnect the AC power cable before cleaning.
- To clean the display unit cabinet, use a clean cloth lightly dampened with a mild detergent.
- It is important that your unit remains dry. Do not get liquids on or inside the unit. If liquid does get inside, have a qualified service technician check it before you power it on again.
- Do not wipe the screen with a cloth or sponge that could scratch the surface.
- To clean the Touchscreen, use window or glass cleaner applied to a clean cloth or sponge. Never apply the cleaner directly to the touchscreen. Do not use alcohol (methyl, ethyl or isopropyl), thinner, benzene, or other abrasive cleaners.



Waste Electrical & Electronic Equipment Directive (WEEE)

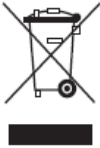

This product should not be disposed of with household waste. It should be deposited at a facility that enables recovery and recycling.

Chapter 7: Regulatory Information

I. Electrical Safety Information:

Compliance is required with respect to the voltage, frequency, and current requirements indicated on the manufacturer's label. Connection to a different power source than those specified herein will likely result in improper operation, damage to the equipment or pose a fire hazard if the limitations are not followed.

There are no operator serviceable parts inside this equipment. There are hazardous voltages generated by this equipment which constitute a safety hazard. Service should be provided only by a qualified service technician.

Contact a qualified electrician or the manufacturer if there are questions about the installation prior to connecting the equipment to mains power.

II. Emissions and Immunity Information

Notice to Users in the United States: This equipment has been tested and found to comply with the limits for a Class B digital device, pursuant to Part 15 of FCC Rules. These limits are designed to provide reasonable protection against harmful interference in a residential installation. This equipment generates, uses, and can radiate radio frequency energy, and if not installed and used in accordance with the instructions, may cause harmful interference to radio communications.

Notice to Users in Canada: This equipment complies with the Class A limits for radio noise emissions from digital apparatus as established by the Radio Interference Regulations of Industrial Canada.

Notice to Users in the European Union: Use only the provided power cords and interconnecting cabling provided with the equipment. Substitution of provided cords and cabling may compromise electrical safety or CE Mark Certification for emissions or immunity as required by the following standards:

This Information Technology Equipment (ITE) is required to have a CE Mark on the Manufacturer's label which means that the equipment has been tested to the following Directives and Standards: This equipment has been tested to the requirements for the CE Mark as required by EMC Directive 89/336/EEC as indicated in European Standard EN 55022 Class A and the Low Voltage Directive 73/23/EEC as indicated in European Standard EN 60950.

General Information to all Users: This equipment generates, uses and can radiate radio frequency energy. If not installed and used according to this manual the equipment may cause interference with radio and television communications. There is, however, no guarantee that interference will not occur in any particular installation due to site-specific factors.

1) In order to meet emission and immunity requirements, the user must observe the following:

a) Use only the provided I/O cables to connect this digital device with any computer.

b) To ensure compliance, use only the provided manufacturer's approved line cord.

c) The user is cautioned that changes or modifications to the equipment not expressly approved by the party responsible for compliance could void the user's authority to operate the equipment.

2) If this equipment appears to cause interference with radio or television reception, or any other device:

a) Verify as an emission source by turning the equipment off and on.

If you determine that this equipment is causing the interference, try to correct the interference by using one or more of the following measures:

i) Move the digital device away from the affected receiver.

ii) Reposition (turn) the digital device with respect to the affected receiver.

iii) Reorient the affected receiver's antenna.

iv) Plug the digital device into a different AC outlet so the digital device and the receiver are on different branch circuits.

v) Disconnect and remove any I/O cables that the digital device does not use.(Un-terminated I/O cables are a potential source of high RF emission levels.)

vi) Plug the digital device into only a grounded outlet receptacle. Do not use AC adapter plugs. (Removing or cutting the line cord ground may increase RF emission levels and may also present a lethal shock hazard to the user.)

If you need additional help, consult your dealer, manufacturer, or an experienced radio or television technician.

III. Agency Certifications

The following certifications and marks have been issued or declared for this monitor:

- CE marking to low voltage directive and EMC directive
- US "NRTL" mark (e.g. UL)
- Canadian "NRTL" mark (e.g. CSA) and ICES EMC labeling
- US FCC, EMC compliance label
- China CCC safety mark and China RoHS marking
- Australia/NZ C-tick EMC mark
- WEEE marking
- RoHS marking
- Korea KC mark EMC
- Russia GOST mark
- Taiwan BSMI mark
- Japan VCCI mark

IV. China RoHS

In accordance to Chinese law (Administration on the Control of Pollution Caused by Electronic Information Products), the section below lists out the name and amount of the toxic and/or hazardous materials that this product may contain.

Component Name	Toxic or Hazardous Substances and Elements					
	Lead(Pb)	Mercury(Hg)	Cadmium(Cd)	Hexavalent Chromium (Cr6+)	Polybrominated Biphenyls (PBB)	Polybrominated Diphenyl Ethers (PBDE)
Plastic Parts	O	O	O	O	O	O
Metal Parts	X	O	O	O	O	O
Wire and Cable Assembly	X	O	O	O	O	O
LCD Panel	X	O	O	O	O	O
Touch Screen Panel	X	O	O	O	O	O
PCBA	X	O	O	O	O	O
Software (CD, etc.)	O	O	O	O	O	O

O: Indicates that this toxic or hazardous substance contained in all of the homogeneous materials for this component is below the limit requirement in SJ/T11363-2006.
X: Indicates that this toxic or hazardous substance contained in at least one of the homogeneous materials used for this component is above the limit requirement in SJ/T11363-2006. For items marked with X, exemptions were taken according to EU RoHS.

Explanation of Markings

(1). In accordance with the SJ/T11364-2006 requirement, the electronic information products are marked with the following pollution control logo. The Environment-Friendly Use Period for this product is 10 years. The product will not leak or mutate under normal operating conditions listed below, so that the use of this electronic information product will not result in any severe environmental pollution, any bodily injury, or damage to any assets.

Operating Temperature:0-35 / Humidity:20%-80% (non-condensing).

Storage Temperature:-20~60 / Humidity:10%~90% (non-condensing).



(2). It is encouraged and recommended that this product be recycled and reused according to local laws. The product should not be thrown away casually.



V. Power Adapter Specifications

Electrical Ratings:

Input: 100-240VAC, 50-60Hz

Output: 12VDC, minimum 3A, LPS

VI. Monitor Specifications

Electrical Ratings:

Input: 12VDC, 3A

Operating Conditions:

Temperature: 0°C - 35°C

Humidity: 20% to 80% (non-condensing)

Altitude: 0 to 3,048m

Storage Conditions:

Temperature: -20°C - 50°C

Humidity: 10% to 90% (non-condensing)

Altitude: 0 to 12,192m

Chapter 8: Warranty Information

Except as otherwise stated herein, or in an order acknowledgment delivered to Buyer, Seller warrants to Buyer that the Product shall be free of defects in materials and workmanship. The warranty for the Touchmonitors and their components is three years.

Seller makes no warranty regarding the model life of components. Seller's suppliers may at any time and from time to time make changes in the components delivered as Products or components.

Buyer shall notify Seller in writing promptly (and in no case later than 30 days after discovery) of the failure of any Product to conform to the warranty set forth above; shall describe in commercially reasonable detail in such notice the symptoms associated with such failure; and shall provide to Seller the opportunity to inspect such Products as installed, if possible. The notice must be received by Seller during the Warranty Period for such product, unless otherwise directed in writing by the Seller. Within thirty days after submitting such notice, Buyer shall package the allegedly defective Product in its original shipping carton(s) or a functional equivalent and shall ship to Seller at Buyer's expense and risk.

Within a reasonable time after receipt of the allegedly defective Product and verification by Seller that the Product fails to meet the warranty set forth above, Seller shall correct such failure by, at Seller's options, either (i) modifying or repairing the Product or (ii) replacing the Product. Such modification, repair, or replacement and the return shipment of the Product with minimum insurance to Buyer shall be at Seller's expense. Buyer shall bear the risk of loss or damage in transit, and may insure the Product. Buyer shall reimburse Seller for transportation cost incurred for Product returned but not found by Seller to be defective. Modification or repair, of Products may, at Seller's option, take place either at Seller's facilities or at Buyer's premises. If Seller is unable to modify, repair, or replace a Product to conform to the warranty set forth above, then Seller shall, at Seller's option, either refund to Buyer or credit to Buyer's account the purchase price of the Product less depreciation calculated on a straight-line basis over Seller's stated Warranty Period.

These remedies shall be the buyer's exclusive remedies for breach of warranty. Except for the express warranty set forth above, seller grants no other warranties, express or implied by statute or otherwise, regarding the products, their fitness for any purpose, their quality, their merchantability, their non-infringement, or otherwise. No employee of Seller or any other party is authorized to make any warranty for the goods other than the warranty set forth herein. Seller's liability under the warranty shall be limited to a refund of the purchase price of the product. In no event shall Seller be liable for the cost of procurement or installation of substitute goods by Buyer or for any special, consequential, indirect, or incidental damages.

Buyer assumes the risk and agrees to indemnify Seller against and hold Seller harmless from all liability relating to (i) assessing the suitability for Buyer's intended use of the Products and of any system design or drawing and (ii) determining the compliance of Buyer's use of the Products with applicable laws, regulations, codes, and standards. Buyer retains and accepts full responsibility for all warranty and other claims relating to or arising from Buyer's products, which include or incorporate Products or components manufactured or supplied by Seller. Buyer is solely responsible for any and all representations and warranties regarding the Products made or authorized by Buyer. Buyer will indemnify Seller and hold Seller harmless from any liability, claims, loss, cost, or expenses (including reasonable attorney's fees) attributable to Buyer's products or representations or warranties concerning same.

Index

- Agency Certifications, 27
- Altitude, 5
- Available Adjustment**
 - Auto Adjust, 21
 - Brightness, 20
 - Clock, 21
 - Color Temperature, 21
 - Contrast, 20
 - H-position, 20, 21
 - Input Video, 21
 - OSD Language, 21
 - OSD Timeout, 21
 - Phase, 21
 - Recall Defaults, 20
 - Sharpness, 21
 - Volume, 21
 - V-position, 20, 21
- cable cover, 14
- calibration, 19
- Care and Handling, 24
- China RoHS, 28
- Classification, 5
- cleaning, 24
- Connections, 14
- Connector Panel & Interfaces, 13
- Disclaimer, 2
- electromagnetic immunity, 7
- Emissions and Immunity Information, 26
- Environmental conditions, 5
- European Standards and Classifications, 6
- Explanation of Markings, 28
- grounding power cord, 24
- headphones, 22
- INGRESS PROTECTION, 5
- Installing Software Drivers, 15
- internal speakers, 22
- Lockouts, 22
 - OSD and Power, 22
- Mode of Operation, 5
- Monitor Specifications, 29
- Mounting Information, 17
 - native resolution, 19
 - online self-help, 23
- On-Screen Display, 20
- Operating, 5
- OSD, 20
 - OSD buttons, 20
- Out Of Range, 23
- Power Adapter Specifications, 28
- Power Status LED, 19
- Problems, 23
 - Out of Range, 23
- Product Description, 12
- Rear VESA Mount, 17
- speakers, 22
- Stand Mounting, 18
- Storage, 5
- Technical Assistance, 23
- TouchTools, 2, 13, 15
- Trademark, 2
- Transportation, 5
- Unpacking, 13
- ventilation, 24
- Video, 19
- Warnings, 3
- Warranty Information, 30
- WEEE, 25

Check out our website

www.elotouch.com

Get the latest...

- Product Information
- Specifications
- Upcoming events
- Press releases
- Software drivers

Getting in Touch with Us

To find out more about the extensive range of Elo touch solutions, visit our website at www.elotouch.com, or simply call the office nearest you:

North America
Elo Touch Solutions
1033 McCarthy Blvd
Milpitas, CA 95035

Tel 800-ELO-TOUCH
Tel + 1 408 597 8000
Fax +1 408 597 8050
customerservice@elotouch.com

Europe
Tel +32 (0) 16 70 45 00
Fax +32 (0)16 70 45 49
elosales@elotouch.com

Asia-Pacific
Tel +86 (21) 3329 1385
Fax +86 (21) 3329 1400
www.elotouch.com.cn

Latin America
Tel 786-923-0251
Fax 305-931-0124
www.elotouch.com